

SARASOTA

Standard Features:

- Advanced unidirectional suspension system
- Premium high-density, high-resiliency foam seat cushions
- Single-needle top-stitch
- In-arm control panel includes 2-amp USB charging port
- Stationary armless seats
- Lifetime warranty on frame and suspension
- Five-year warranty on mechanism
- Three-year warranty on motor
- Quick-ship delivery

Options:

- Premium high-density, high-resiliency foam seat cushions encased in down
- Back cushion options: **Hills** (channels), **Ridge** (saddle) or **Valley** (tufted)
- Contrasting stitch detail available in Black, Brown, Charcoal, Cream, Espresso, Grey, Lemon, Pink, Royal, Scarlet, Tangerine, or Teal thread color
- Option of motion in armless seats
- Lithium-ion battery pack available
- Battery pack has one-year warranty
- Wood legs available in Acorn, Espresso or Walnut finish

Please use actual leather, fabric, Crypton®, Sunbrella® and Ultrasuede® swatches when specifying furniture as the colors shown may vary due to the printing process.

Note: Microfiber fabrics such as SUEDELIFE and VEELIFE not suggested for this style. Please contact American Leather® Support Services for a complete list of recommended fabrics.

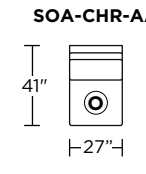
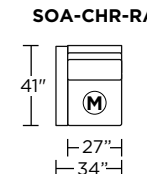
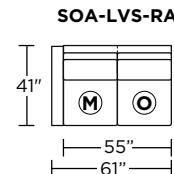
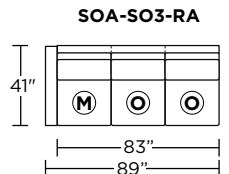
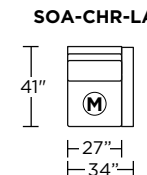
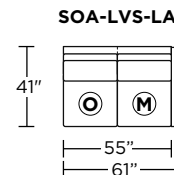
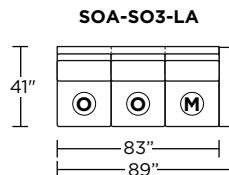
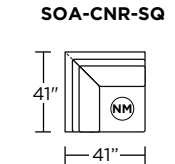
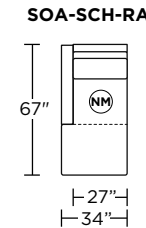
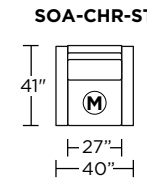
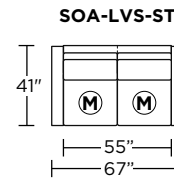
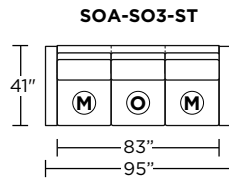
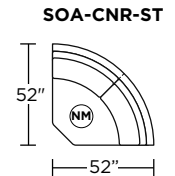
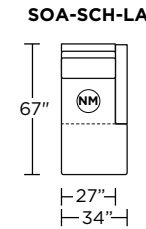
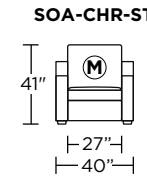
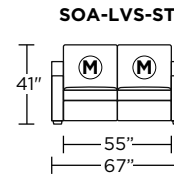
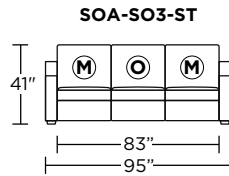
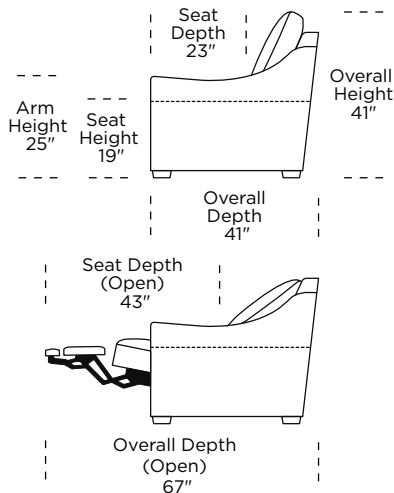

MOTION LEGEND:

- (M) = Motion only
- (O) = Optional motion or stationary
- (NM) = No motion available

BACK CUSHION OPTIONS:

- Hills (Channels)**
- Ridge (Saddle)**
- Valley (Tufted)**

Note: Dotted line indicates seam on leather, Ultrasuede® and up the roll fabrics. Seams are eliminated with railroaded fabrics.

Scale: 1/8 inch = 1 foot
 All dimensions are approximate and subject to change.
 Specify components from the sitting position.