

BARIS

Standard Features:

- Premium high-density, high-resiliency foam seat
- Loose back and tight seat cushions
- Unique seat cushion design doubles as a mattress section
- Zero wall clearance
- Single-needle top-stitch
- Lifetime warranty on frame
- Limited three-year warranty on mechanism
- Quick-ship delivery

Options:

- Wood legs in Acorn, Espresso or Walnut finish

Mattress:

- Four inches of high-density, high-resiliency foam

Leg height is 4"

Please use actual leather, fabric, Crypton®, Sunbrella® and Ultrasuede® swatches when specifying furniture as the colors shown may vary due to the printing process.

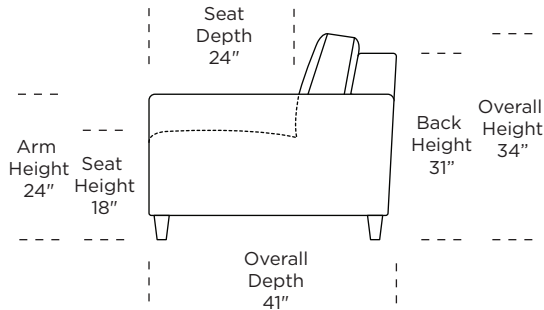
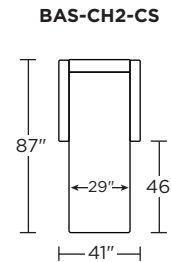
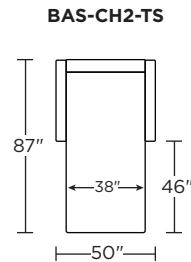
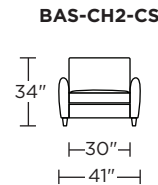
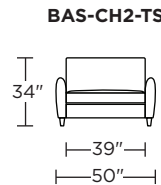
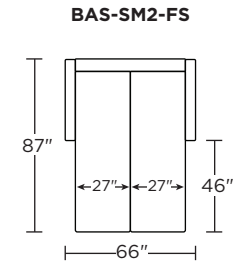
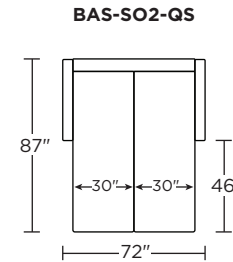
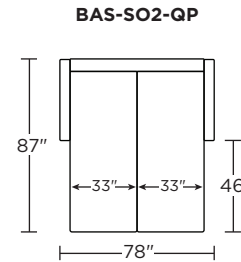
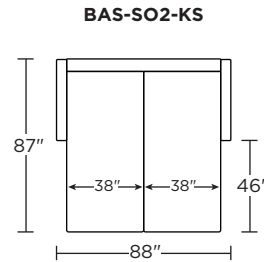
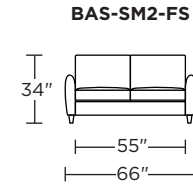
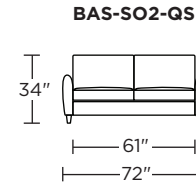
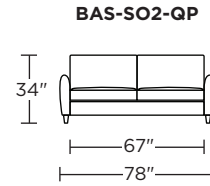
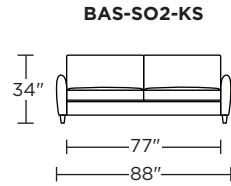

Scale: 1/8 inch = 1 foot
All dimensions are approximate and subject to change.
Specify components from the sitting position.